





PROFITEMP+ HOT RUNNER CONTROLLER

The profiTEMP+ Hot runner controller convinces with both innovative technology and space-saving design. There are new, intelligent functions like Smart Power Limitation (SPL) and MoldCheck. In addition, the standard features have been enhanced in the new hot runner controller. Due to the clearly designed 7" multi-touch screen, an easy and intuitive operation is guaranteed.

MOLDCHECK - EFFICIENT INSPECTION OF THE HOT RUNNER SYSTEM

Even before the startup of the mould, a fully automatic wiring check can be carried out. It is also possible to check the status of the heaters and sensors in the hot runner.

ADVANTAGES DURING THE INJECTION MOULDING PROCESS

- » Exact power output through high resolution of the actuating signal on the heating output
- » Uniform, controlled heating-up with automatic ramp
- » Relay heating - heating up of zone groups in a sequence
- » Monitoring of the sensor signal to detect sensor break, polarity reversal and short-circuits
- » Safety shutdown for individual zones upon detection of a critical error in the heating circuit
- » Early detection of leaks through continuous process monitoring





TRANSPARENT PROCESSES

CONTINUOUS MONITORING OF PROCESSES

The well-designed algorithms of profiTEMP+ monitor the processes of your machine and give immediate feedback in the event of malfunction. Through this preventive measure potential damages can be avoided.

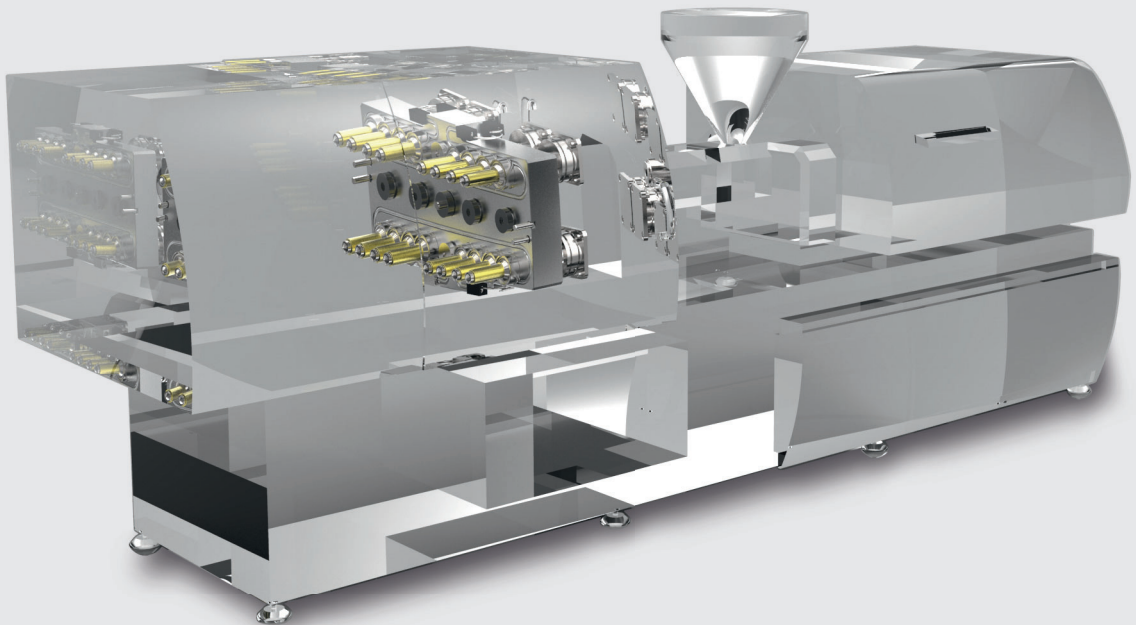

NO LOSS OF CONTROL

The heating current is measured without interruption of control and output of the heating pulses. Since the measurement does not influence the control performance, profiTEMP+ measures much more frequently and therefore guarantees prompt and almost uninterrupted monitoring.

OPERATING RELIABILITY

SMART POWER LIMITATION - OUTPUT LIMITATION AND INTELLIGENT POWER DISTRIBUTION

The intelligent function for limiting the power prevents the heating power required by the heating outputs from exceeding the available connecting power.

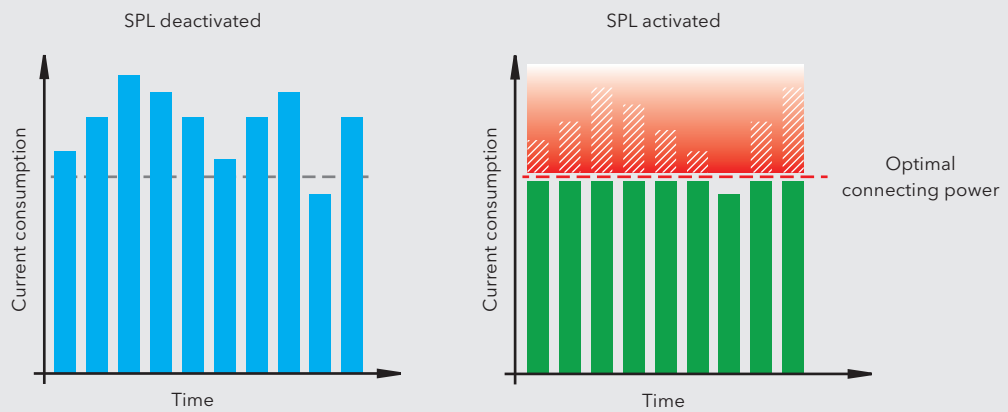

SMART PEAK REDUCTION - REDUCES PEAK LOADS THROUGH UNIFORM CONTROL PULSE DISTRIBUTION

The controller guarantees that the heating power is distributed as uniformly as possible in the zones. This is how profiTEMP+ prevents power peaks and power fluctuations.

OPERATION

INTUITIVELY DESIGNED MULTI-TOUCH SCREEN

The operation of profiTEMP+ with the modern multi-touch screen is as simple as using your smartphone or tablet. All process data is clearly presented. You can choose between various graphic view types.



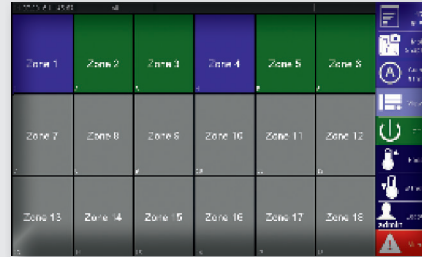

STANDARD

Zoom-in view of the most important process data.

ALL ZONES

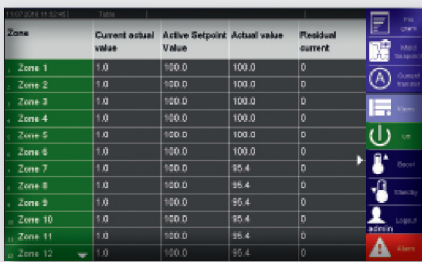
All zones at a glance - the status is identified in colour.

TABLE VIEW

The clearly displayed parameters can be individually selected.

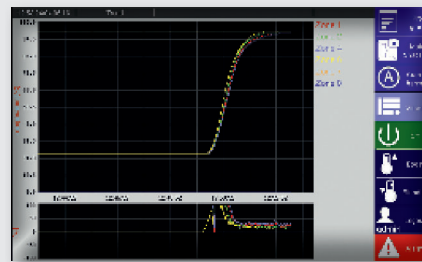
TREND

Temperatures and output values are displayed as curves.

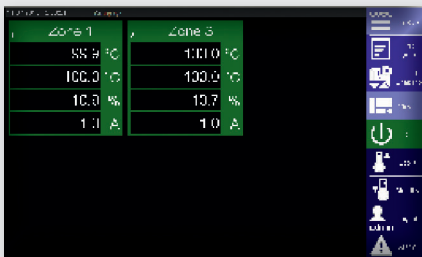
GROUP

The zones combined into groups are clearly displayed.

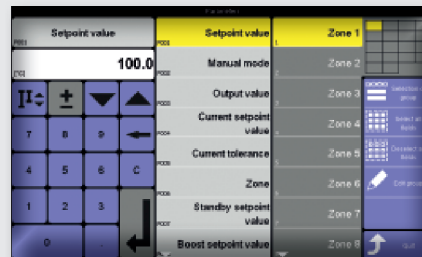
INPUT MASK

The standardised method makes the operation easier.

ALARM

Current alarms are analysed so that malfunctions can be directly repaired.

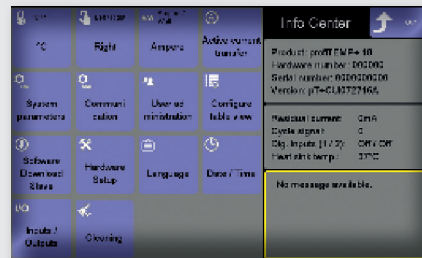
CONFIGURATION & INFO CENTRE

The user can adapt the system to individual requirements.